

INDEX	INDEX	INDEX	ÍNDICE
COD.			PAG.
V8 Flow - Cod.900.0207			420
V8 Port Ring H=2,2 - Cod.900.0208			421
V13 Flow Ball Clip - Cod.900.0196			422
V13-V20 Port Ring H=2,2 - Cod.900.0210			423
V20 Flow - Cod.900.0209			424
V20-V13 Port Ring H=2,2 - Cod.900.0210			425
V28 Flow - Cod.900.0125			426
V28-V45 Port Ring H=3,0 - Cod.900.0160			427
V45 Flow Glued - Cod.900.0535			428
V45 Flow RH-LH - Cod.900.0174			429
V45-V28 Port Ring H=3,0 - Cod.900.0160			430
V85 Flow - Cod.900.0203			431
V130 Flow Ball Clip - Cod.900.0500			432

EXCHANGERS

ECHANGEURS

WÄRMEAUSTAUSCHER

INTERCAMBIADORES

Pos	Orobica Code	Model	Brand	Gasket Type	Q.ty
-	900.0207	V8	VICARB	FLOWPLATE GASKET	-

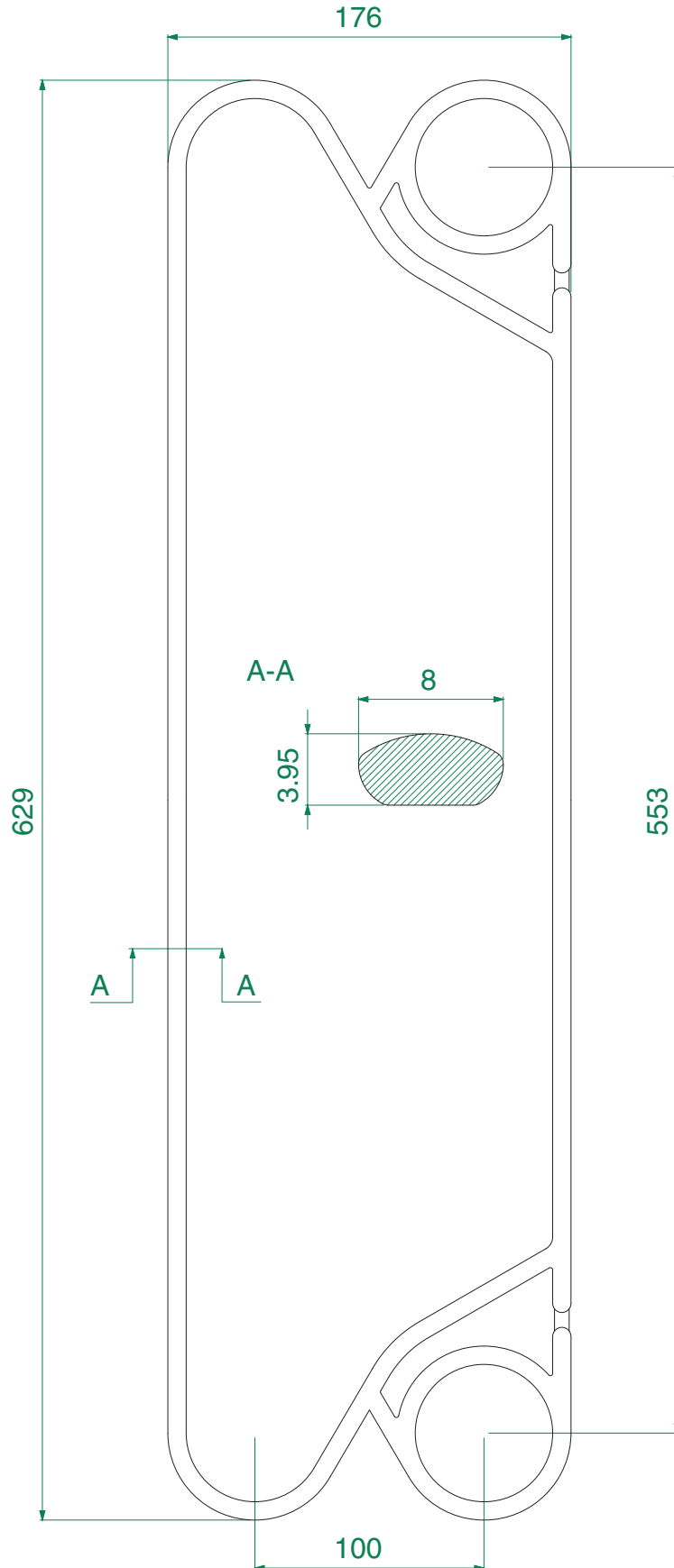

EXCHANGERS

ECHANGEURS

WÄRMEAUSTAUSCHER

INTERCAMBIADORES

Pos	Orobica Code	Model	Brand	Gasket Type	Q.ty
-	900.0208	V8	VICARB	PORT RING	-

1:1 SCALE

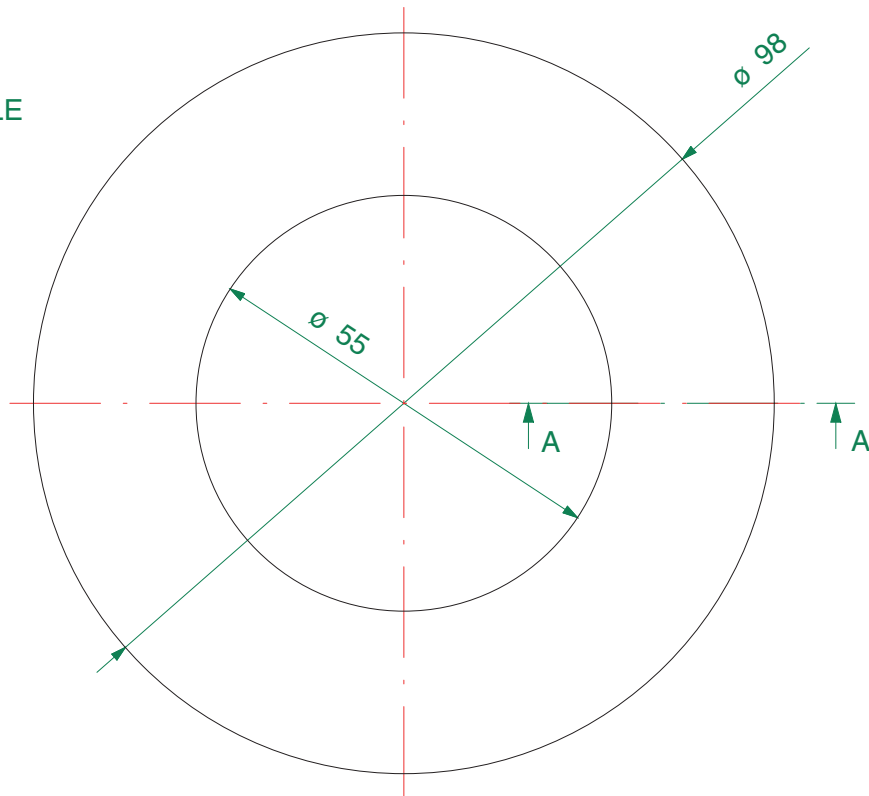

EXCHANGERS

ECHANGEURS

WÄRMEAUSTAUSCHER

INTERCAMBIADORES

Pos	Orobica Code	Model	Brand	Gasket Type	Q.ty
-	900.0196	V13	VICARB	FLOW GASKET BALL CLIP	-

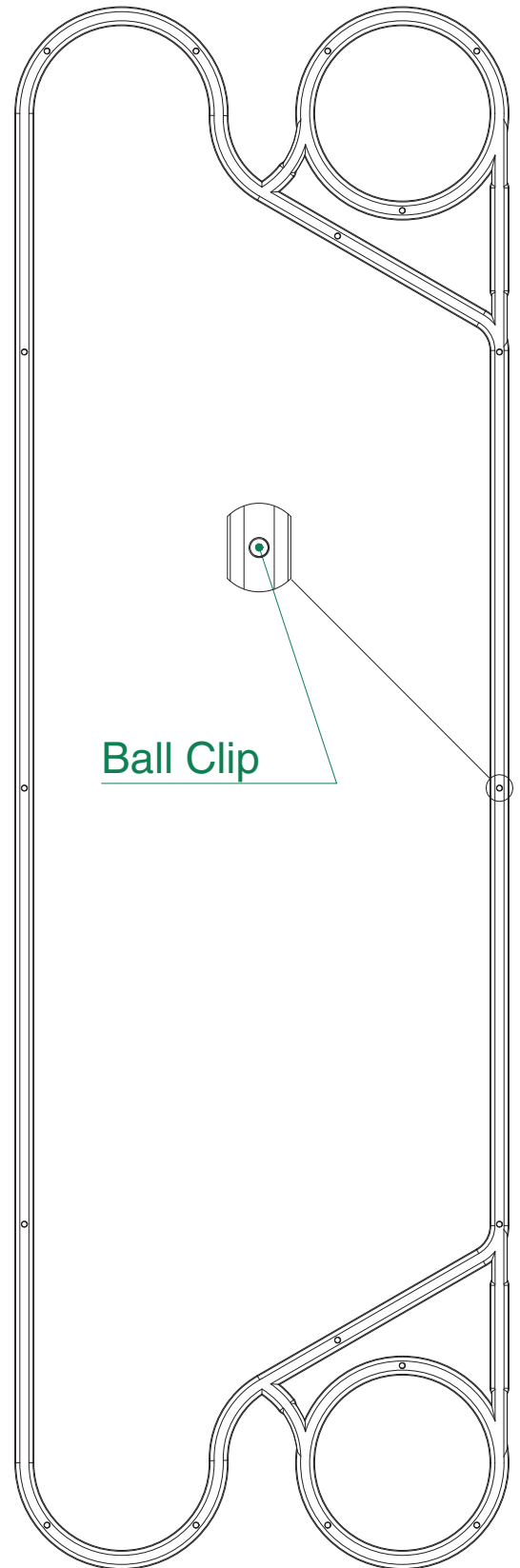
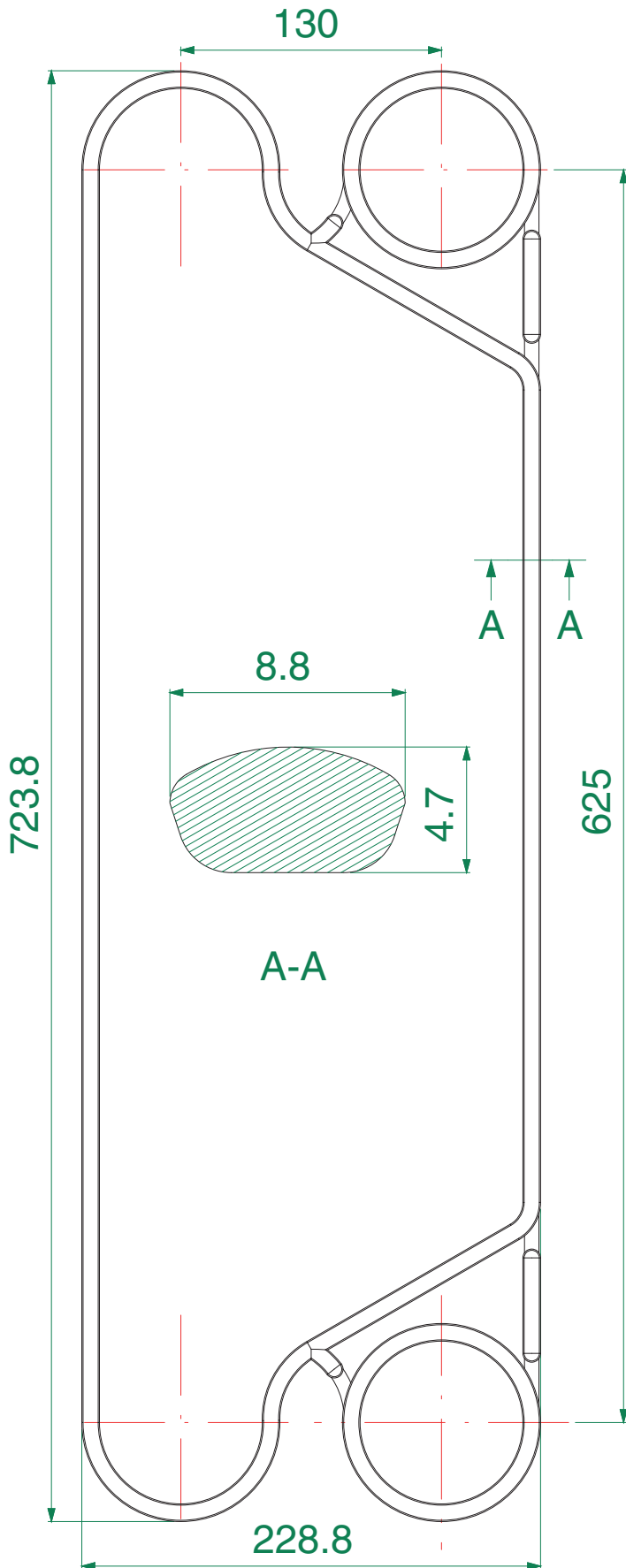

Pos	Orobica Code	Model	Brand	Gasket Type	Q.ty
-	900.0210	V13-V20	VICARB	PORT RING GASKET	-

1:1 SCALE

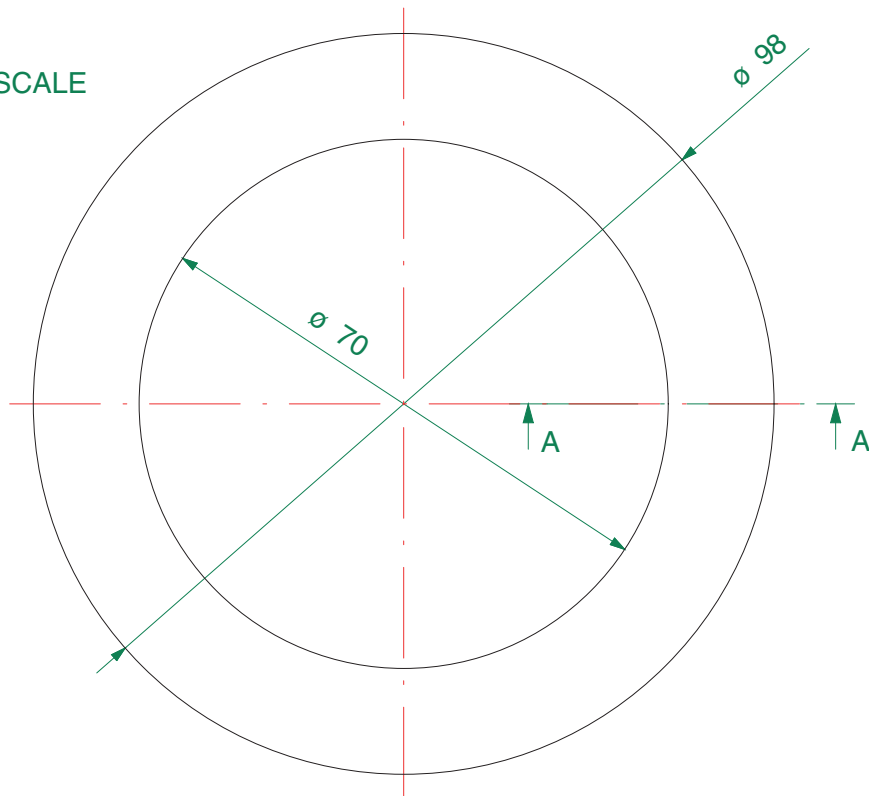

A-A

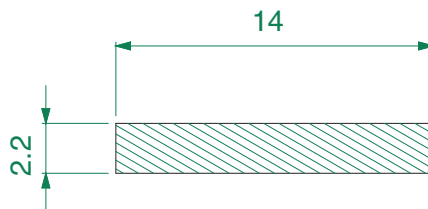

EXCHANGERS

ECHANGEURS

WÄRMEAUSTAUSCHER

INTERCAMBIADORES

Pos	Orobica Code	Model	Brand	Gasket Type	Q.ty
-	900.0209	V20	VICARB	FLOWPLATE GASKET	-

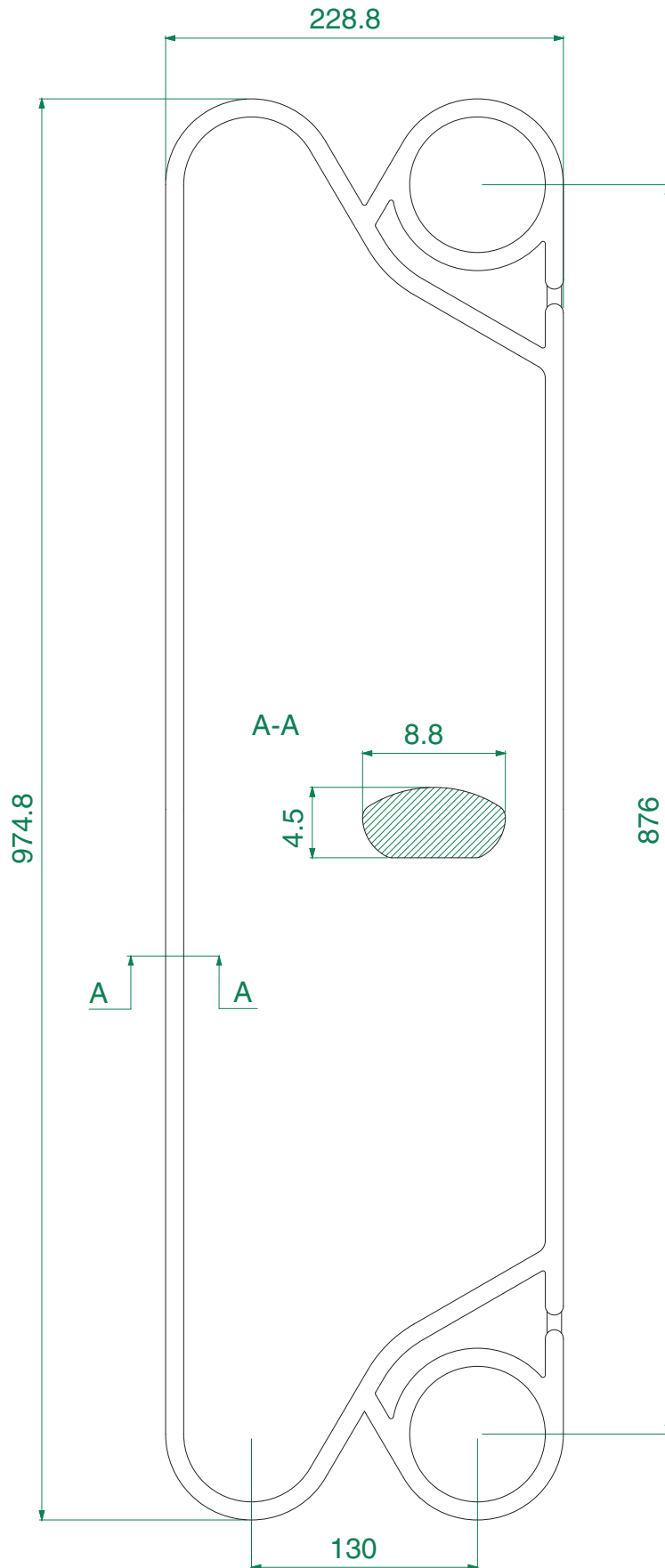

Pos	Orobica Code	Model	Brand	Gasket Type	Q.ty
-	900.0210	V13-V20	VICARB	PORT RING GASKET	-

1:1 SCALE

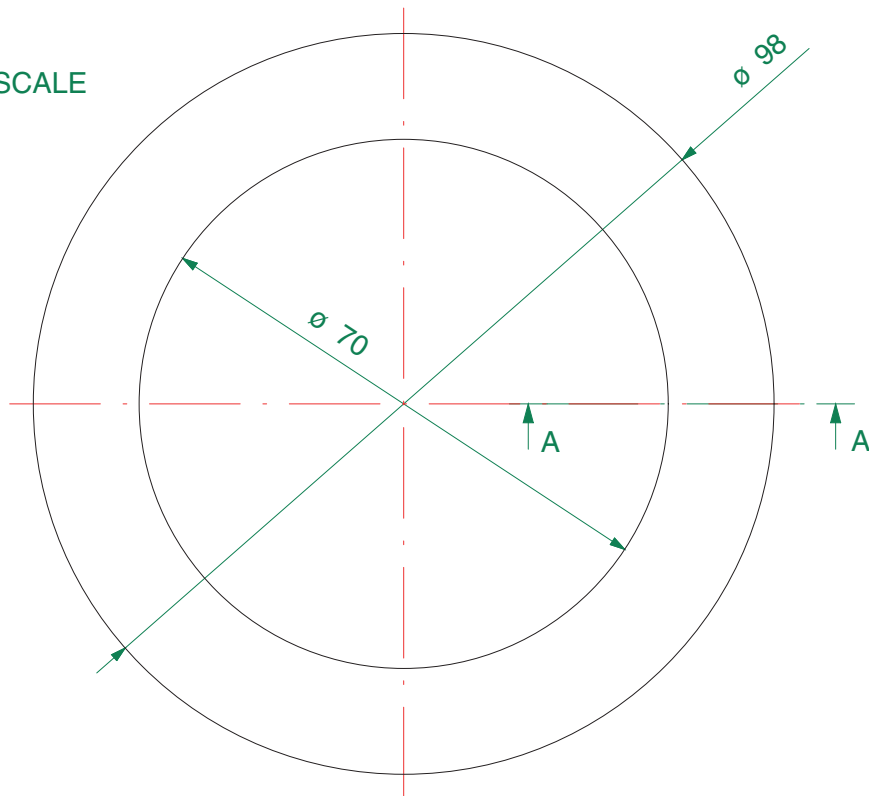

A-A

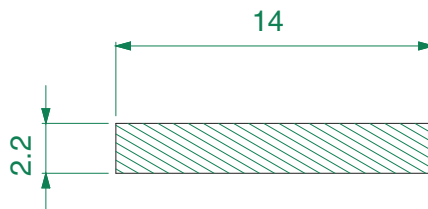

Pos	Orobica Code	Model	Brand	Gasket Type	Q.ty
-	900.0125	V28	VICARB	FLOWPLATE GASKET	-

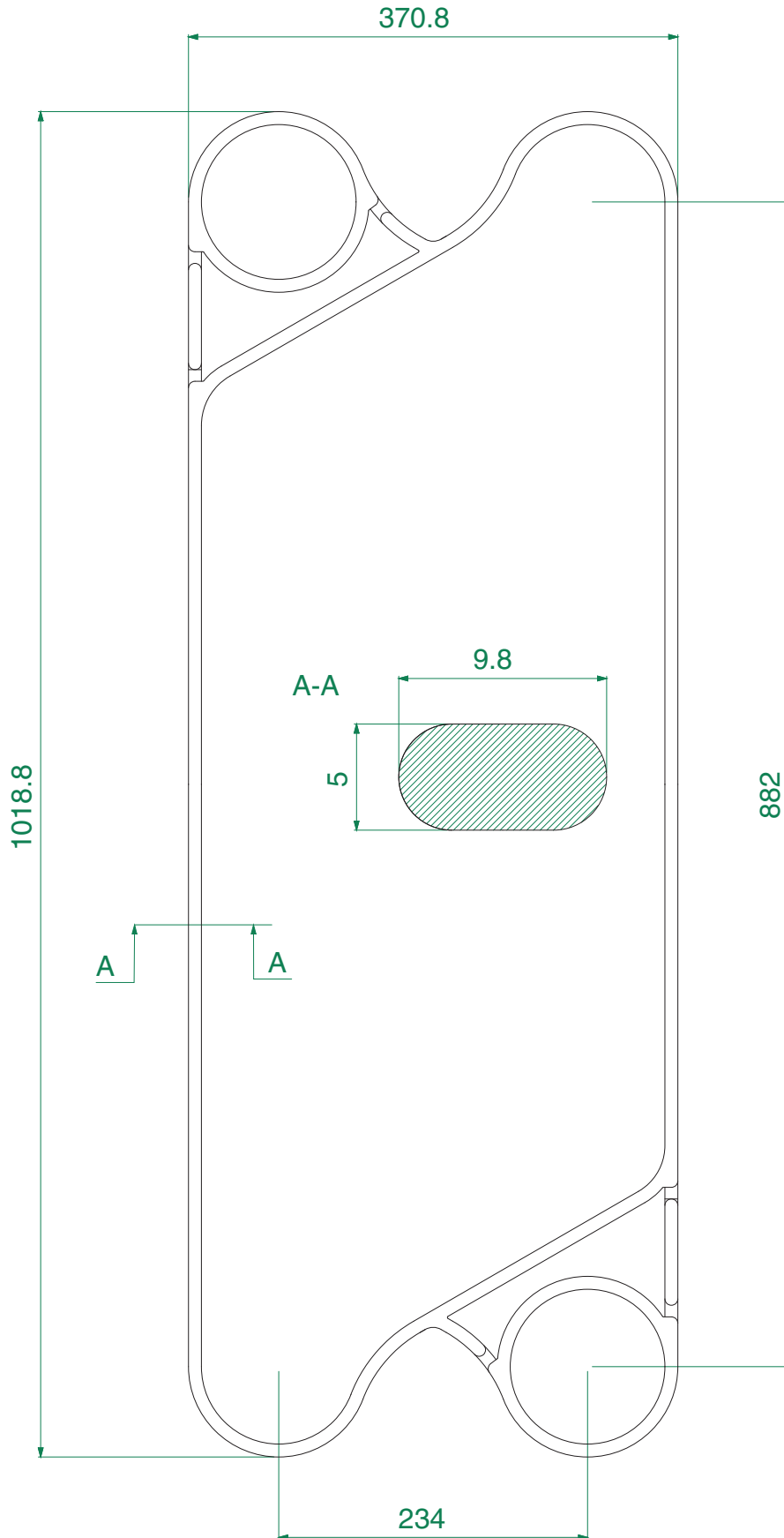

EXCHANGERS

ECHANGEURS

WÄRMEAUSTAUSCHER

INTERCAMBIADORES

Pos	Orobica Code	Model	Brand	Gasket Type	Q.ty
-	900.0160	V28-V45	VICARB	PORT RING GASKET	-

1:1 SCALE

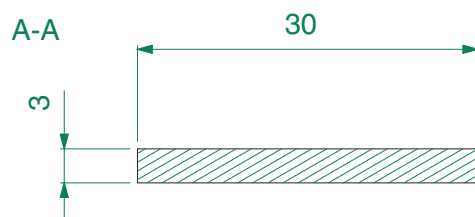
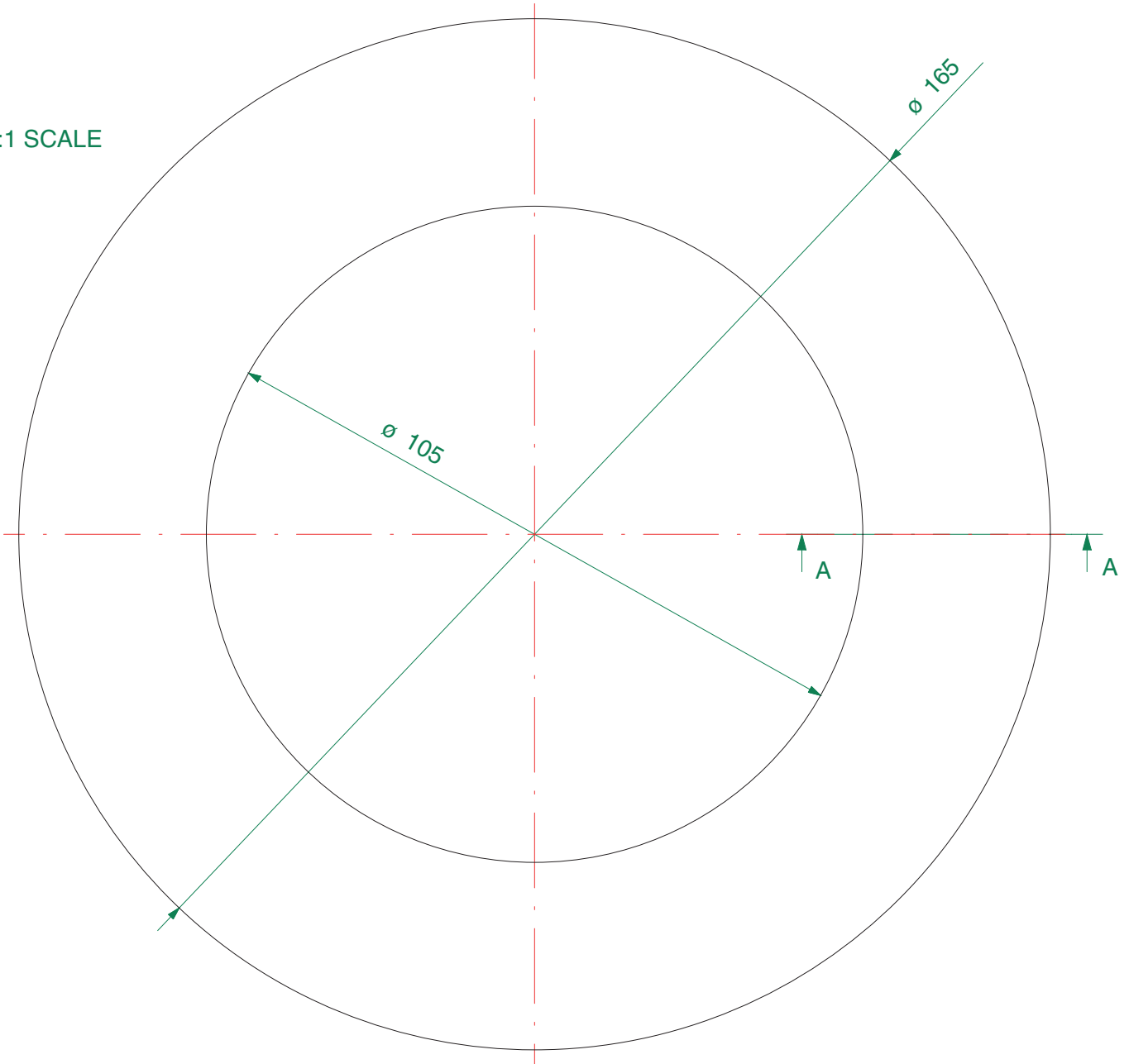

Pos	Orobica Code	Model	Brand	Gasket Type	Q.ty
-	900.0535	V45	VICARB	GLUED FLOW GASKET CHANNEL PLATE	-

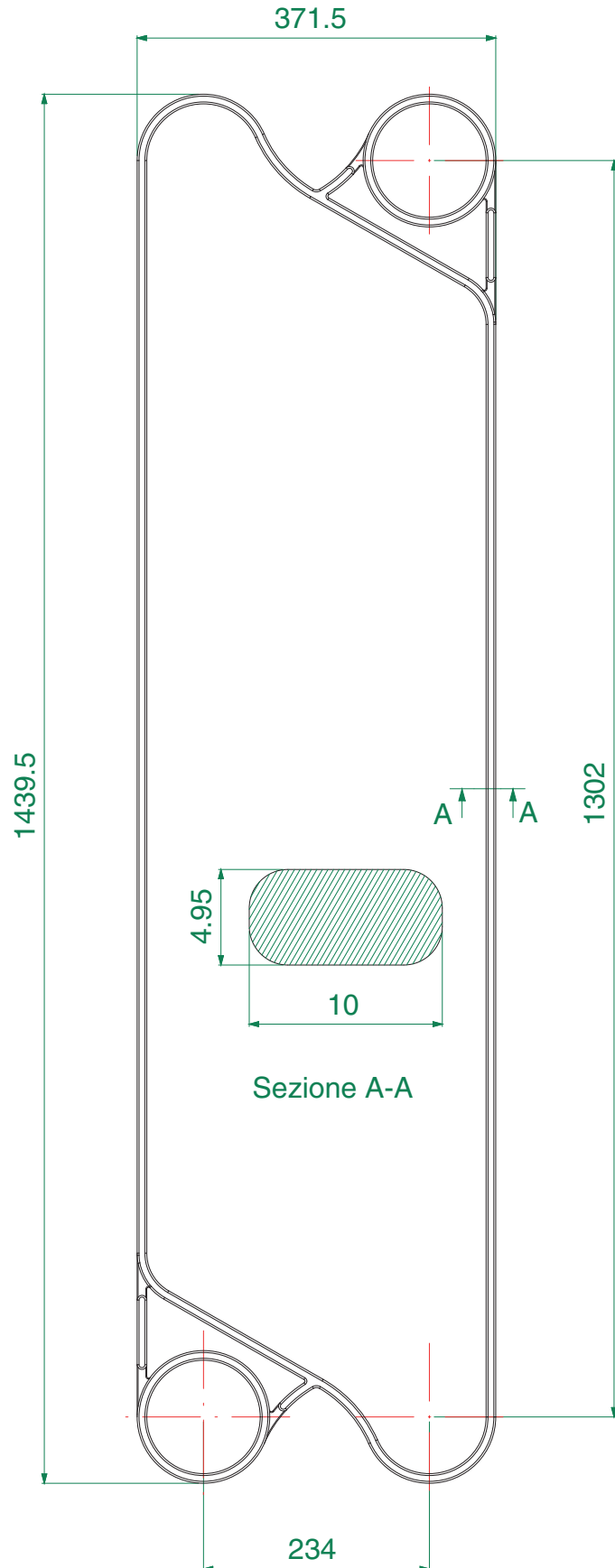

EXCHANGERS

ECHANGEURS

WÄRMEAUSTAUSCHER

INTERCAMBIADORES

Pos	Orobica Code	Model	Brand	Gasket Type	Q.ty
01	900.0174	V45	VICARB	FLOW GASKET RIGHT	-
02	900.01741	V45	VICARB	FLOW GASKET LEFT	-

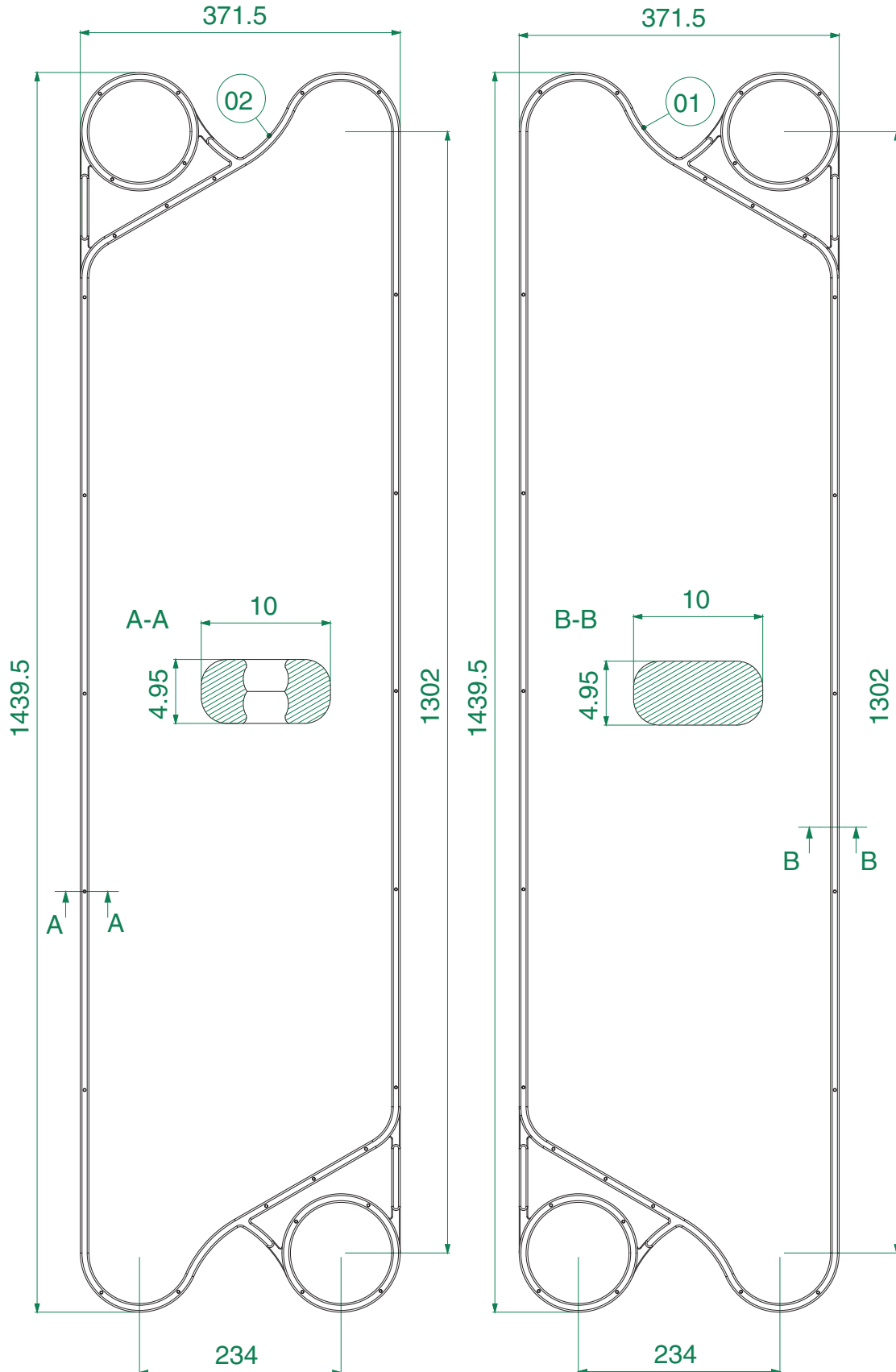

EXCHANGERS

ECHANGEURS

WÄRMEAUSTAUSCHER

INTERCAMBIADORES

Pos	Orobica Code	Model	Brand	Gasket Type	Q.ty
-	900.0160	V28-V45	VICARB	PORT RING GASKET	-

1:1 SCALE

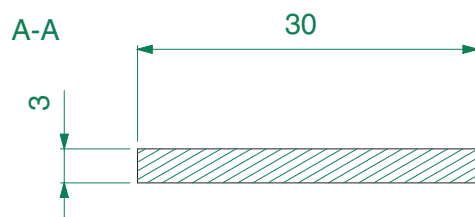
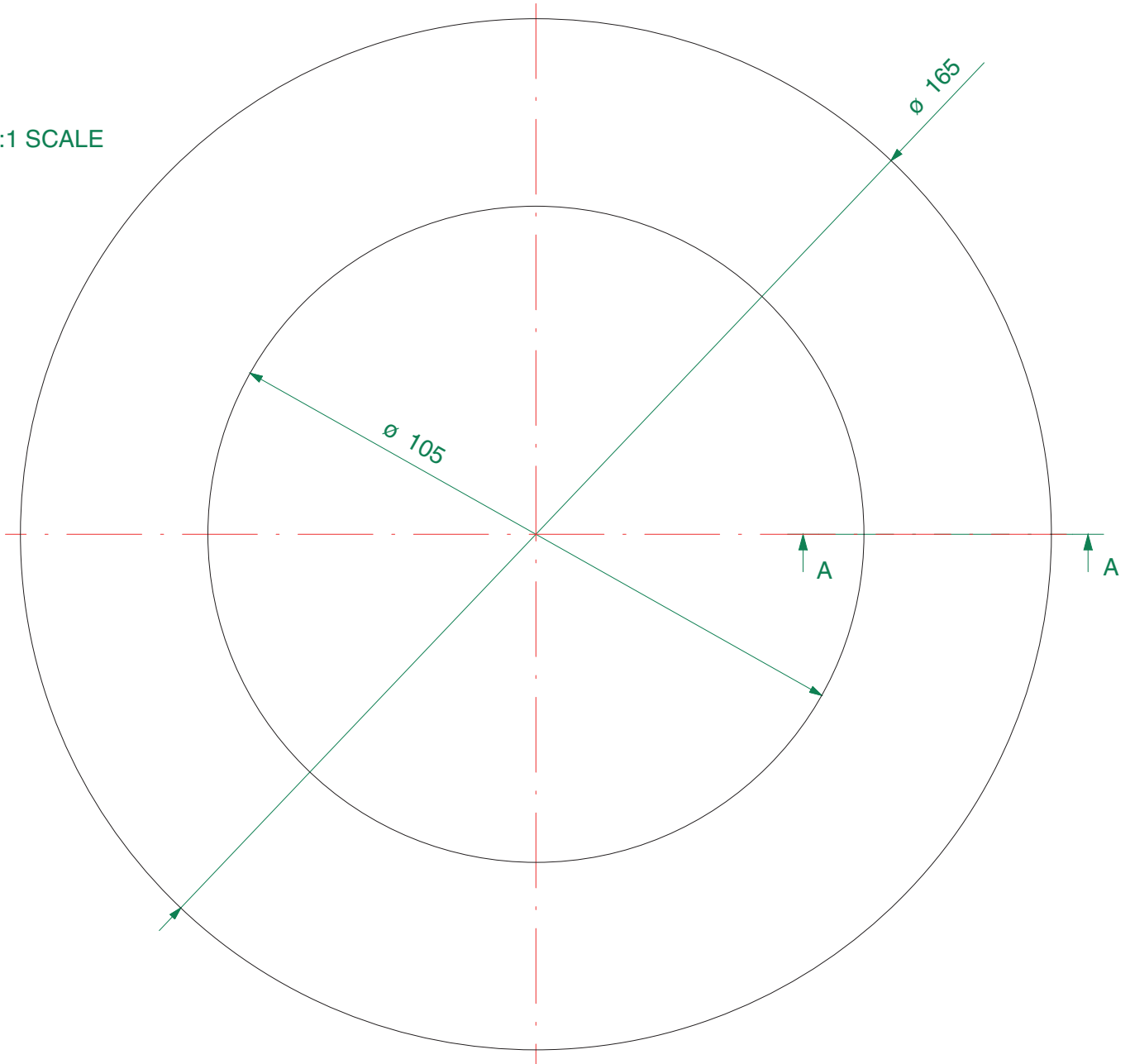

EXCHANGERS

ECHANGEURS

WÄRMEAUSTAUSCHER

INTERCAMBIADORES

Pos	Orobica Code	Model	Brand	Gasket Type	Q.ty
-	900.0203	V85	VICARB	FLOWPLATE GASKET	-

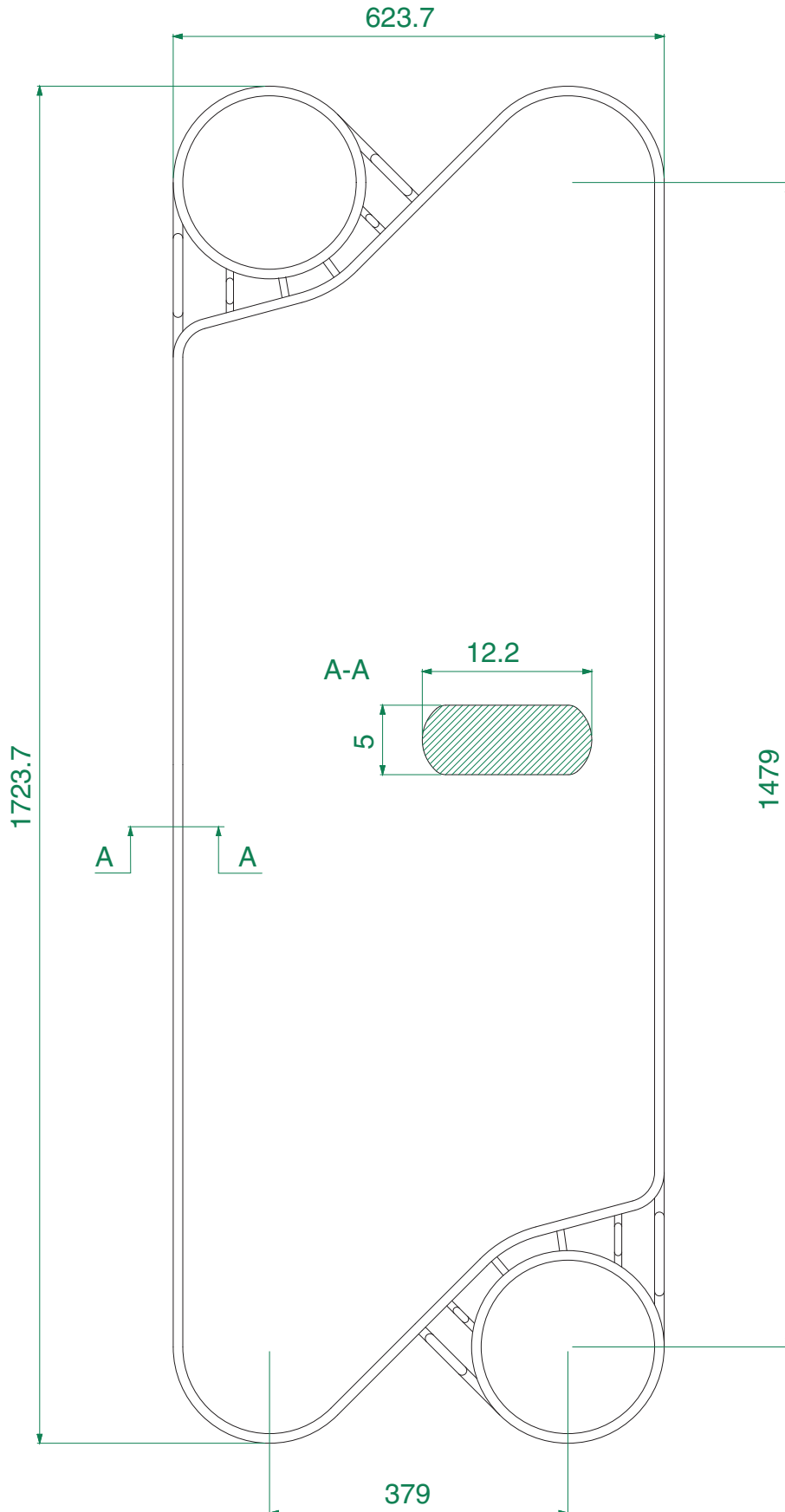

EXCHANGERS

ECHANGEURS

WÄRMEAUSTAUSCHER

INTERCAMBIADORES

Pos	Orobica Code	Model	Brand	Gasket Type	Q.ty
-	900.0500	V130	VICARB	FLOW GASKET BALL CLIP	-

