

## GUARNIZIONI PER RIEMPITRICI

FILLING MACHINE SEALS  
DICHTUNGEN FÜR ABFÜLLMASCHINEN

JOINTS POUR SOUTIREUSES  
JUNTAS PARA LLENADORAS

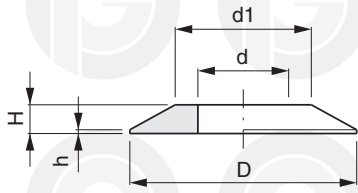

COD.	D	d	d1	H	h
035.0056	21.3	10.9	16.8	3.2	1.7
035.0013	24	10.5	16.5	4	0.25
035.0008	24	11	16.8	3.3	0.8
035.0055	24.4	11.8	19.4	3	1.85
035.0005	26	12.1	18	3.5	0.5
035.0006	26	11.6	17	3.5	0.4
035.0054	26	12	19.2	3	1.30
035.0007	27	11.5	19	3.5	0.4
035.0002	28	15	18	3.8	1.5
035.0009	28	11.8	18	3.5	0.5
035.0001	30	12	18	3.8	0.5
035.0003	34	21	27	3	0.6
035.0004	34	19	27	3	0.6
035.0010	36	22.5	29	3	1.75
035.0011	36	19	27.5	3.4	1
035.0012	37	21	31	3	1

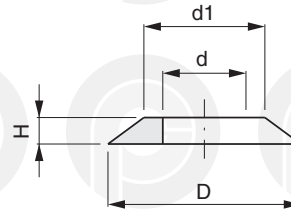

COD.	D	d	d1	H
035.0052	24	8	13	5
035.0050	25.5	11	16	3.5
035.0051	26	10	17	3.7
035.0053	30	18	27	6

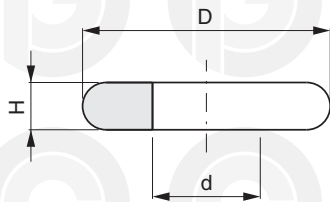

COD.	D	d	H
035.0101	8	2	2.5
035.0107	8	2.3	1.8
035.0123	8	2.5	2.3
035.0122	8.5	2.2	2.4
035.0110	8.5	2.5	2.5
035.0130	8.6	3.2	2.6
035.0104	9	2	2.5
035.0112	9	2.7	2.4
035.0113	10	4.7	2.4
035.0116	10	3.2	2.4
035.0120	10.6	5.2	2.6
035.0102	11	4.7	2.4
035.0114	11	4.4	2.5
035.0117	11	4	2.5
035.0127	11.2	6.2	2.5
035.0100	12	4.8	2.6
035.0103	12	4.4	2.4
035.0105	12	4	2.5
035.0121	13	5.8	2.5
035.0115	13.1	5.7	2.5
035.0111	15.5	7.3	2.62
035.0106	18	10.5	2.5
035.0109	18.8	10.6	2.62
035.0108	27	14	3

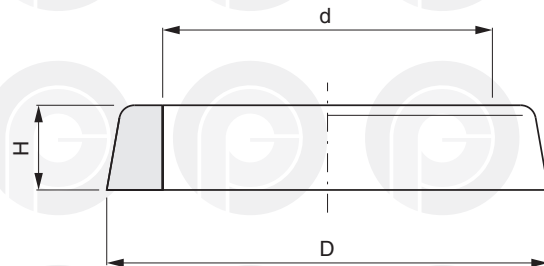

COD.	D	d	H
035.0200	69.3	50	12.5
035.0201	73	54.5	13
035.0202	73.5	57	12.5

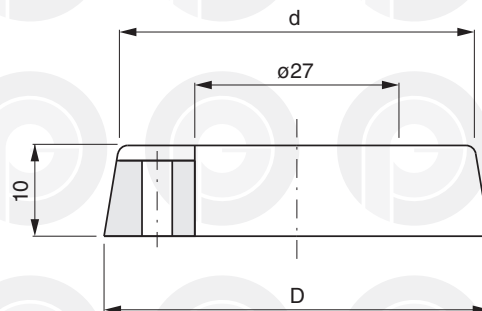

COD.	D	d
035.0205	47.5	42.3
035.0206	51	45

## GUARNIZIONI PER RIEMPITRICI

**FILLING MACHINE SEALS**  
**DICHTUNGEN FÜR ABFÜLLMASCHINEN**

**JOINTS POUR SOUTIREUSES**  
**JUNTAS PARA LLENADORAS**

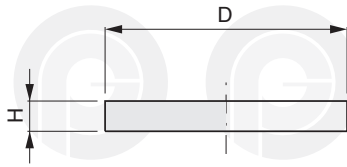

COD.	D	H
035.0213	11	2
035.0210	12.5	3
035.0211	12.5	5
035.0212	14	2

035.0220

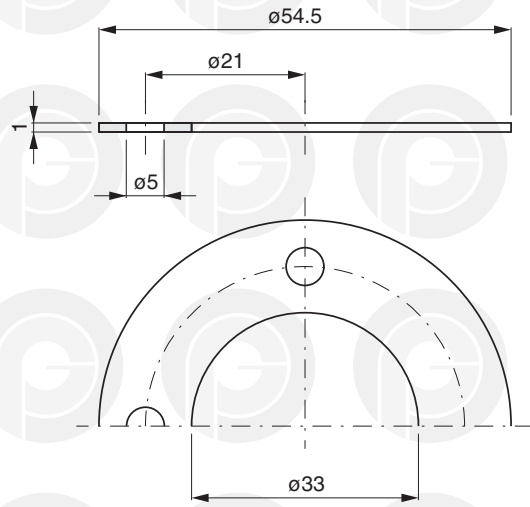

035.0221

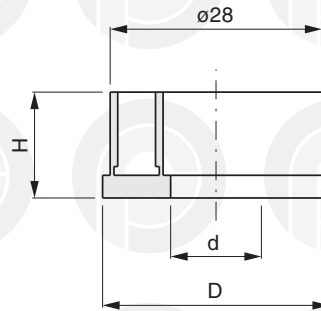
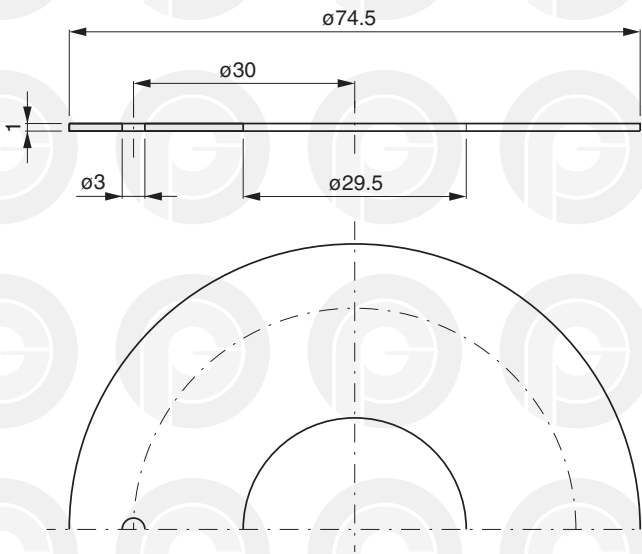

COD.	D	d	h
035.0304	30	11	11.9
035.0305	31	10	14

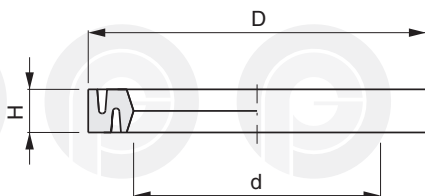

COD.	D	d	H
035.0315	16.5	7.5	2.3
035.0313	18	9.5	2.3
035.0319	20.5	11.5	2.3
035.0311	28	19.4	2.7
035.0310	30.7	20	2.7
035.0312	32.5	20.5	2.7

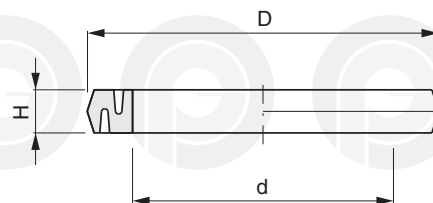

COD.	D	d	h
035.0301	40	29	2.7
035.0300	45	34.5	2.7

## GUARNIZIONI PER RIEMPITRICI

FILLING MACHINE SEALS  
DICHTUNGEN FÜR ABFÜLLMASCHINEN

JOINTS POUR SOUTIREUSES  
JUNTAS PARA LLENADORAS

035.0302



035.0303

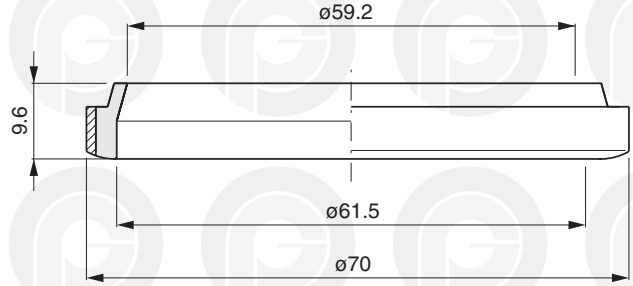

035.0306

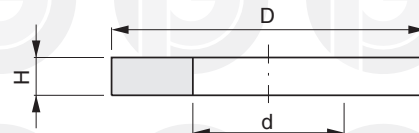
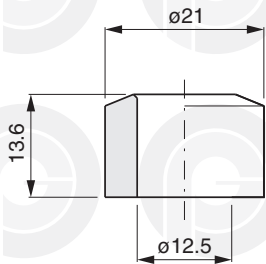

COD.	D	d	H
035.1004	10	6	4
035.1017	11.3	5.5	1.6
035.1007	11.4	6.1	1.5
035.1008	11.4	5.4	1.5
035.1025	12	5.5	1.5
035.1012	16.6	5.5	2
035.1018	21	5.5	1.9
035.1019	22.8	14.2	3
035.1013	24.5	12	4
035.1003	26	14.2	3
035.1011	27	10	3
035.1016	27.5	12	1.9
034.0486	34	13.8	10

COD.	D	d	H
034.1014	34	20	6
034.0458	34.5	14.4	10
035.1000	34.5	17	5
035.1001	34.5	15	5
200.0036	35	11.5	12
034.0507	40	13.5	10
035.1002	40	24	4
035.1020	43.8	27	2
035.1015	50	32	3
035.1021	55.5	25.3	15
035.1006	74.5	45	10
035.1005	97	70.5	1

035.0309

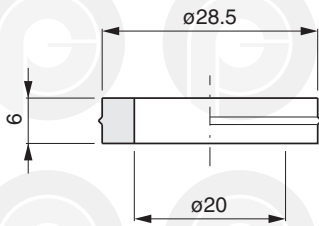

035.0324

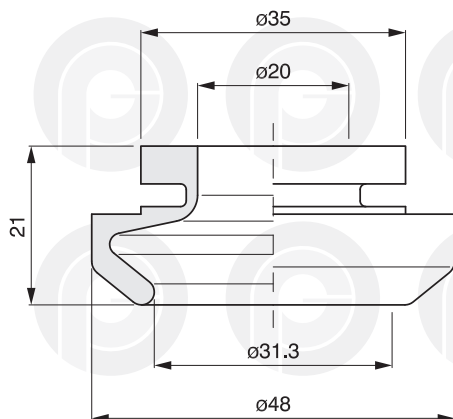

035.0327

